

Varenummer: 58MI16S0160CAP
 Beskrivelse: Cylinder MI-16x160-S-CA, Ø16x160
 gummidæmpning - port M5

Mål

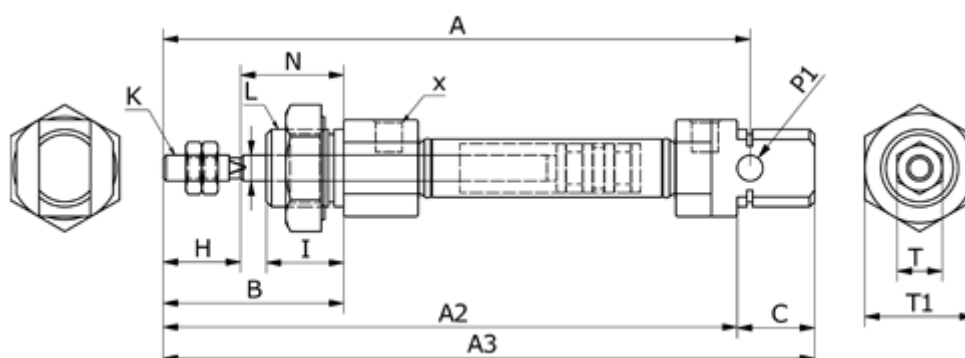

A	= 98	K	= M6x1,0	V = 6
A2	= 56	L	= M16x1,5	X = M5x0,8
A3	= 111	N	= 22	
B	= 38	O	= 13	
Boringsdiameter	= 16	P1	= 6	
C	= 17	Slaglængde	= 160	
HS	= 16	T	= 10	
I	= 17	T1	= 22	